

Protection is a concrete idea.

Hi-R Masonry Wall System Tips for The Masonry Contractor

Concrete Block Insulating Systems
P.O. Box 1000
Freight House Road
West Brookfield, MA 01585-1000

508.867.4241
800.628.8476
Fax: 508.867.5702

www.cbisinc.com
E-mail: korfil@cbisinc.com
Member of NCMA and EPSMA



IMPORTANT

Before laying any Hi-R Blocks, first read the following "key points" and then the attached Hi-R Masonry Wall System Tips for Block Manufacturers.

Key Points:

- 1.) **Do Not** turn blocks upside down. The blocks should be laid upright as shown in the attached drawings
- 2.) The Hi-R System works only with Ladder Type Wall Reinforcing with 16 inch butt welded center cross ties. The ties are placed directly over webs of blocks to allow the innermost insert to be pushed down to lock with the insert below it.
- 3.) Remove the innermost insert on the starter course. This is done to make certain any mortar that may have fallen under the inner insert does not prevent inserts on the next course from being pushed downward.

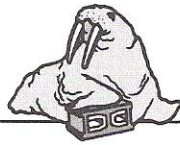

Protection is a concrete idea.

HI-R MASONRY WALL SYSTEM TIPS FOR THE MASONRY CONTRACTOR

Because of the unique design of the Hi-R System, your masons and tenders will need brief instructions as to the minor differences between the Hi-R wall system and a regular block wall.

Hi-R Block comes to the job site pre-insulated by the block manufacturer.

Hi-R production is in direct relation to your company's expectations. Generally, the same number of units you estimate for laying an architectural block (8", 10" or 12") can be expected. The Hi-R block is 18% lighter and after a short learning curve, production is normal, with less back-ache.

Hi-R blocks have an unobstructed cavity for grouting and re-bar placement, with either a running or stacked bond. Webs remain aligned. If possible, give General Contractor information on the proper spacing and location for vertical re-bar placement in grade beam to avoid bending rods or cutting block.

Care should be taken in job site handling to avoid chippage and breakage. Your forklift operator should exercise caution on rough terrain.

The system is designed to use a 3/8" mortar joint, head and bed. Less mortar should be placed on the bed joint as the Hi-R blocks are 1/8" greater in height at the inside of the face shell (7 3/4") than at the face (7 5/8"). After the mason lays block in place the "B" insert is tapped down to meet the one below. If there is no flexibility to tap "B" insert down on starter course, use "A" insert only. (See #6)

It is helpful toward optimum production to remove end tabs by saw cutting prior to building lead or jamb. (See #12)

Wire for Hi-R wall system is ladder type with cross members at 16" increments. It is produced by all leading manufacturers. Cross member should always be placed over web. (See #5)

For use as a bond beam one or both inserts may be removed if necessary. Delete inserts at loadbearing points directly under bar-joist, pre-cast beams, etc. Consult your project architect and engineer for approval.

Concrete Block Insulating Systems

P.O. Box 1000
Freight House Road
West Brookfield, MA 01585-1000

508.867.4241
800.628.8476
Fax: 508.867.5702

www.cbisinc.com
E-mail: korfil@cbisinc.com
Member of NCMA and EPSMA

At the end of work day, make sure "B" insert is tapped down to avoid a height gain (excess mortar gets under insert and hardens) in next days work process.

Daily clean up and picking up loose inserts makes a safer job and a happier General Contractor and Owner.

Korfil Sales Managers and Engineers are calling on architects, engineers and national accounts daily promoting block buildings. We stand ready to help the Masonry Contractor in a joint effort to keep masonry in the forefront and masons working. Glass, Window-Wall, Tilt-Up or Pre-Cast DOES NOT put money in your pocket. OUR SYSTEM DOES!

For additional information call your local block producer or

CONCRETE BLOCK INSULATING SYSTEMS, INC. at 1-800-628-8476

1. HI-R MASONRY UNITS SHOWN LAID UPRIGHT AS OPPOSED TO STANDARD UNITS LAID INVERTED.
2. HI-R INSULATION INSERTS INTERLOCKING TOP, BOTTOM AND SIDES.
3. SPECIALLY ENGINEERED TWO (2) PART INSERT.
4. HORIZONTAL AND VERTICAL GROUTED REINFORCEMENT IF REQUIRED (ALSO NOTE 13.)
5. PREFABRICATED LADDER STYLE HORIZONTAL JOINT REINFORCEMENT (PLACEMENT OF CROSS MEMBERS AT CENTER OF WEBS) 16" ON CENTER.
6. STARTER COURSE TO HAVE OUTER INSERT. REMOVE INNER INSERT TO AVOID ANY POSSIBLE CONTACT WITH MORTAR ON BOTTOM.
7. WIRE SCREEN OR METAL LATH UNDER BOND BEAM.
8. HI-R BLOCK USED AS BOND BEAM.
9. BOND BEAM HORIZONTAL AND VERTICAL REINFORCEMENT.
10. STANDARD SASH BLOCK UTILIZING STANDARD KORFIL INSULATION INSERTS.
11. STANDARD CORNER BLOCK UTILIZING STANDARD KORFIL INSULATION INSERTS.
12. HI-R BLOCK END TABS REMOVED EITHER BY TROWEL OR SAW CUTTING WHEN USED WITH STANDARD ASTM C-90 MASONRY UNITS.
13. IF REQUIRED, PLACEMENT OF VERTICAL REINFORCEMENT TO START AS SHOWN AND IN MULTIPLES OF 8 INCHES APART THEREAFTER NOTING LOCAL BUILDING CODES.
14. HEIGHT OF HI-R BLOCK IS 7 5/8 INCHES REQUIRING A 3/8 INCH MORTAR JOINT.
15. 3/8 INCH MORTAR JOINT. CARE SHOULD BE TAKEN TO MINIMIZE PLACEMENT OF MORTAR ON HI-R INSERTS.

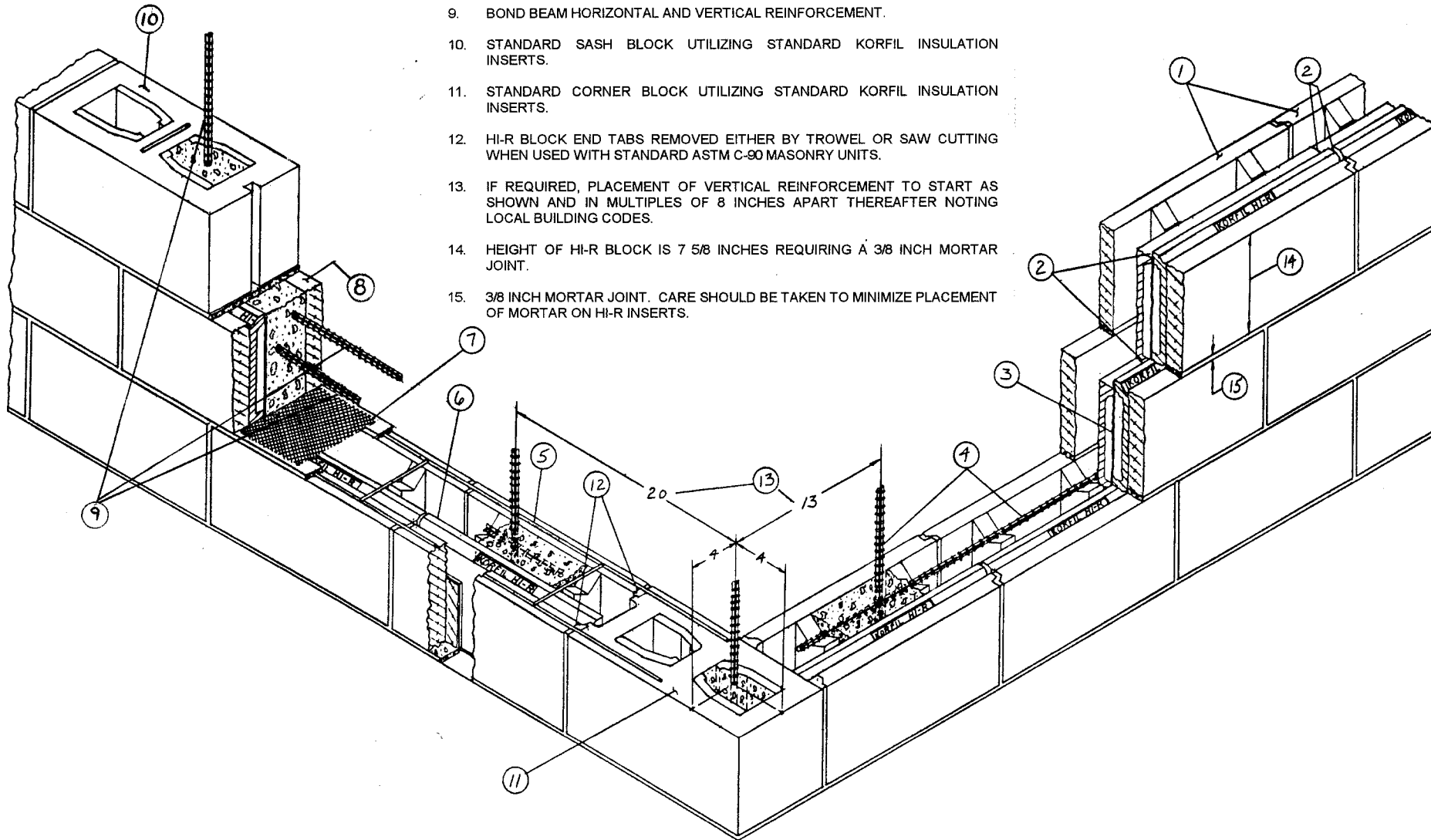

KORFIL HI-R MASONRY WALL SYSTEM

Hi-R Masonry Wall System Grout Areas with Inserts in Place

8 Inch Units

$$\begin{aligned}\text{Volume} &= 2.3 \times 8.0 \times (16 - 2.6) \\ &= 246.6 \text{ inches}^3\end{aligned}$$

$$1 \text{ cu yd} = 46,656 \text{ inches}^3$$

Approx 189 8-inch Hi-R Blocks with Inserts can be grouted with 1 cu yd.

10 Inch Units

$$\begin{aligned}\text{Volume} &= 3.6 \times 8.0 \times (16 - 2.6) \\ &= 385.9 \text{ inches}^3\end{aligned}$$

$$1 \text{ cu yd} = 46,656 \text{ inches}^3$$

Approx 121 10-inch Hi-R Blocks with Inserts can be grouted with 1 cu yd.

12 Inch Units

$$\begin{aligned}\text{Volume} &= 5.6 \times 8.0 \times (16 - 2.6) \\ &= 600.3 \text{ inches}^3\end{aligned}$$

$$1 \text{ cu yd} = 46,656 \text{ inches}^3$$

Approx 78 12-inch Hi-R Blocks with Inserts can be grouted with 1 cu yd.

D.L. Nickerson, P.E.
22 July 2003

CBIS/Korfil

HI-R Drawing Details

Table Of Contents

HI-R Drawing Number

- 1. 8", 10", & 12" Rapid Control Joint**
- 2. 8", 10", & 12" Control Joint**
- 3. 8" Standard Corner**
- 4. 10" & 12" Reinforced Corner**
- 5. 8", 10", & 12" Standard Door Jamb**
- 6. 8", 10", & 12" Standard Window Jamb**
- 7. 8" Thru Wall Base**
- 8. 10" Thru Wall Base**
- 9. 12" Thru Wall Base**
- 10. 8" Window Head Thru Flashing**
- 11. 10" Window Head Thru Flashing**
- 12. 12" Window Head Thru Flashing**
- 14. 8" Thru Wall Base (Alt.)**
- 15. 8" Window Head Thru Flashing (Alt.)**
- 16. 8", 10", & 12" Optional Door Jamb**
- 17. 8", 10", & 12" Optional Window Jamb**
- 18. 12" Alternate Corner**

HI-R[®] WALL SYSTEM

8", 10" & 12" Rapid Control Joint Detail

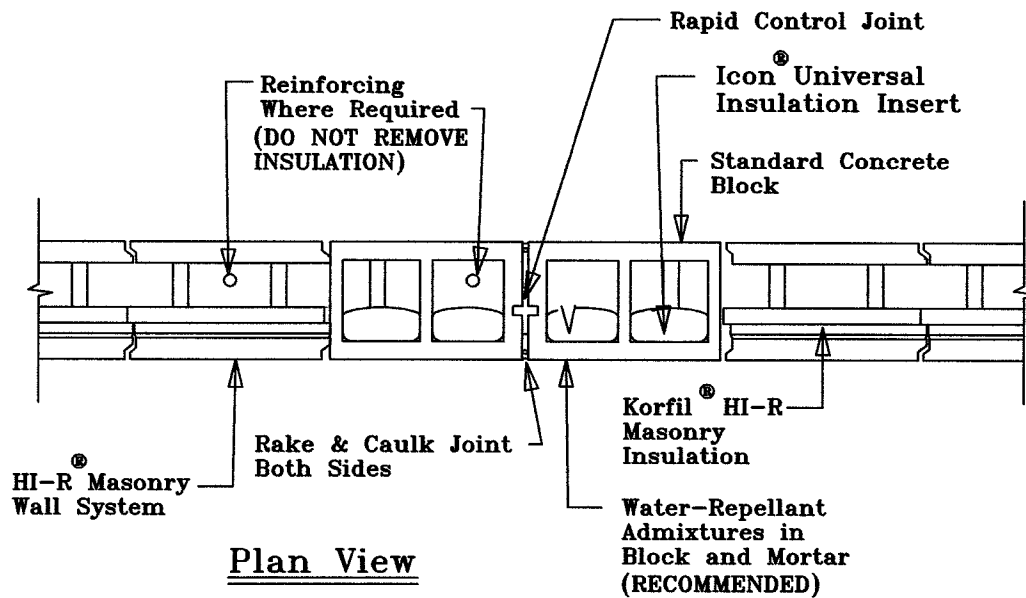
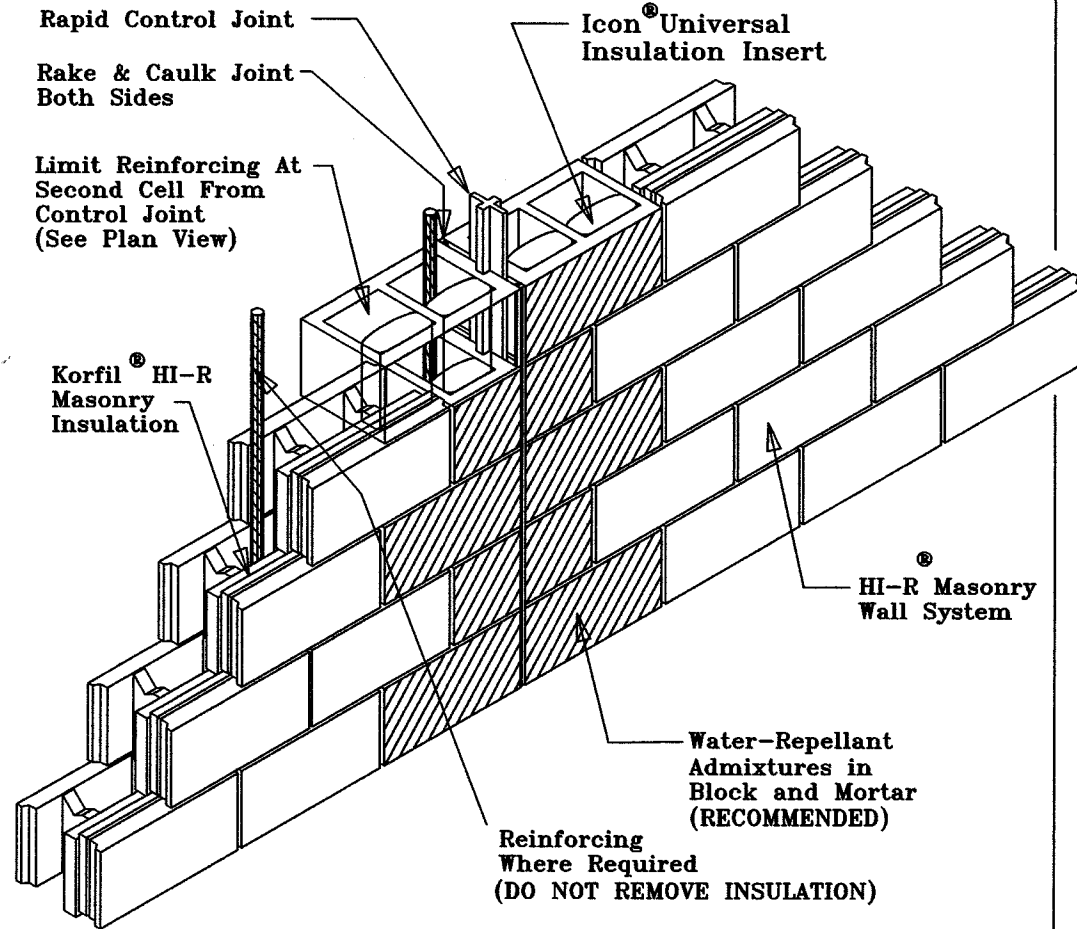

Plan View

DETAILS

6/1/01 | HI-R 1

NOTICE: This Detail is for the Discretionary Use of the Architect. CBIS Assumes No Responsibility For Any Misuse Or Misrepresentation of the Product Or This Detail.

Concrete Block Insulating Systems
 P.O. Box 1000
 Freight House Road
 West Brookfield, MA 01585
 www.cbisinc.com



HI-R[®] WALL SYSTEM

8", 10", & 12" Control Joint Detail

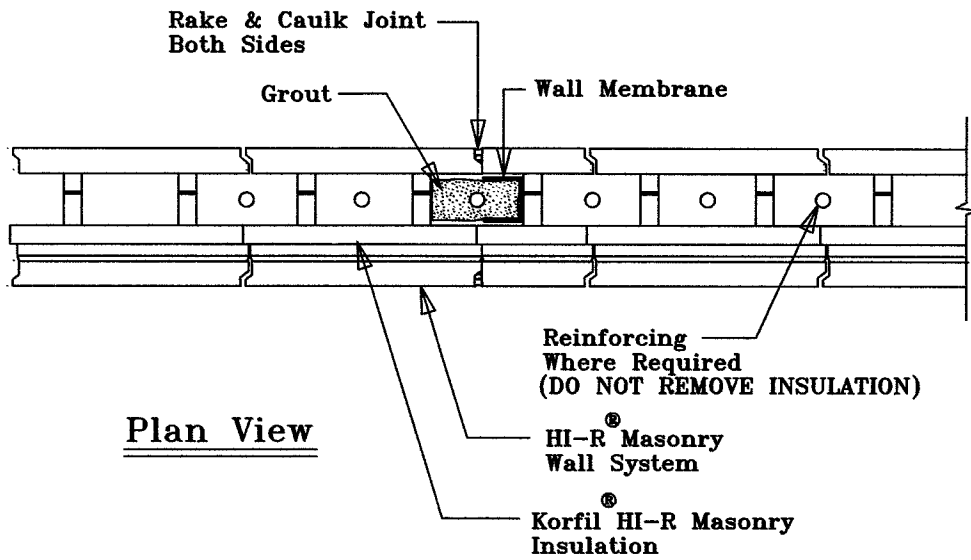
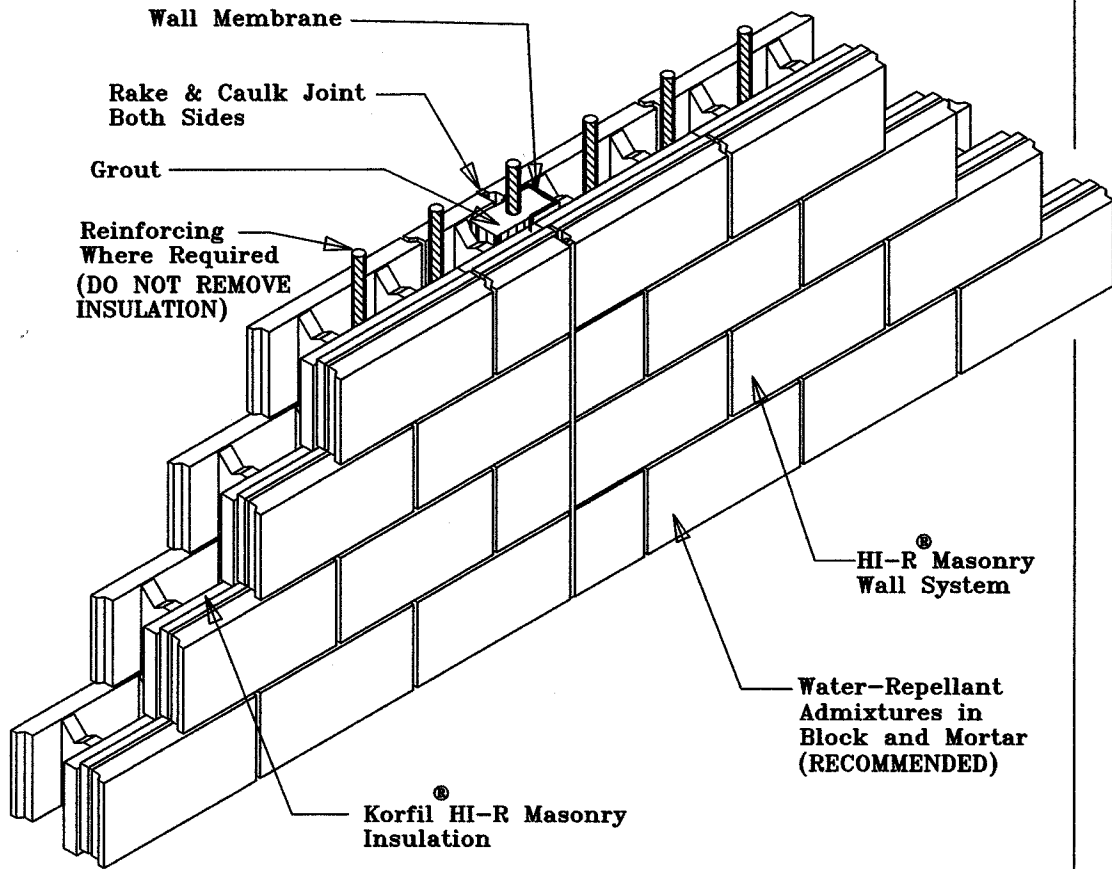

Plan View

DETAILS

6/1/01 HI-R 2



NOTICE: This Detail is for the Discretionary Use of the Architect. CBIS Assumes No Responsibility For Any Misuse Or Misrepresentation of the Product Or This Detail.

Concrete Block Insulating Systems
 P.O. Box 1000
 Freight House Road
 West Brookfield, MA 01585
 www.cbisinc.com

HI-R[®] WALL SYSTEM

8" Standard Corner Detail

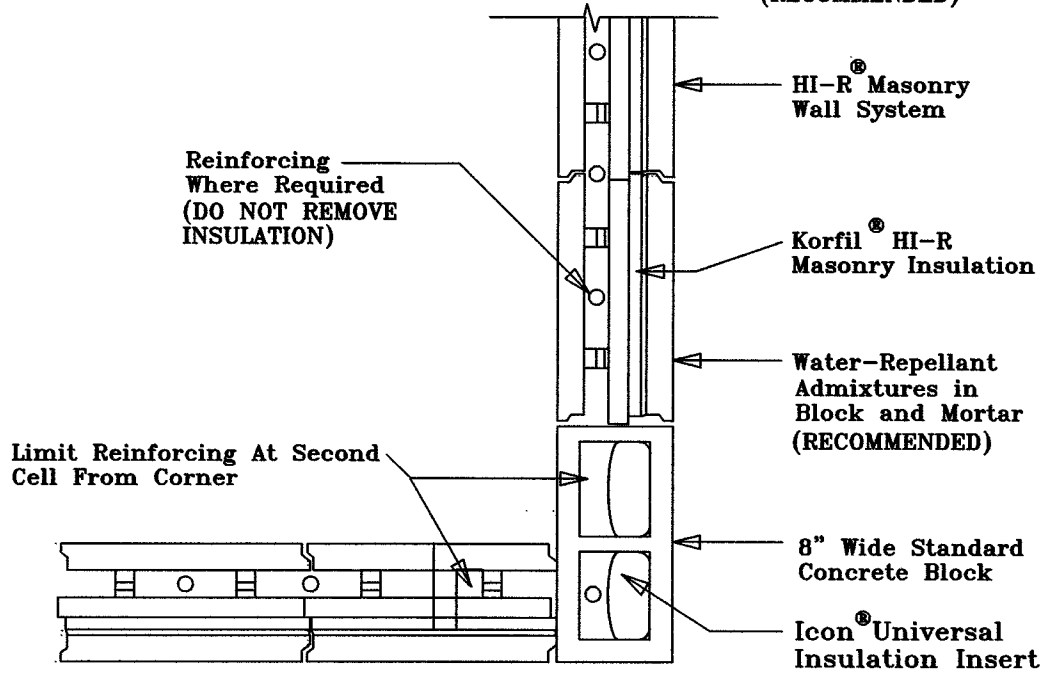
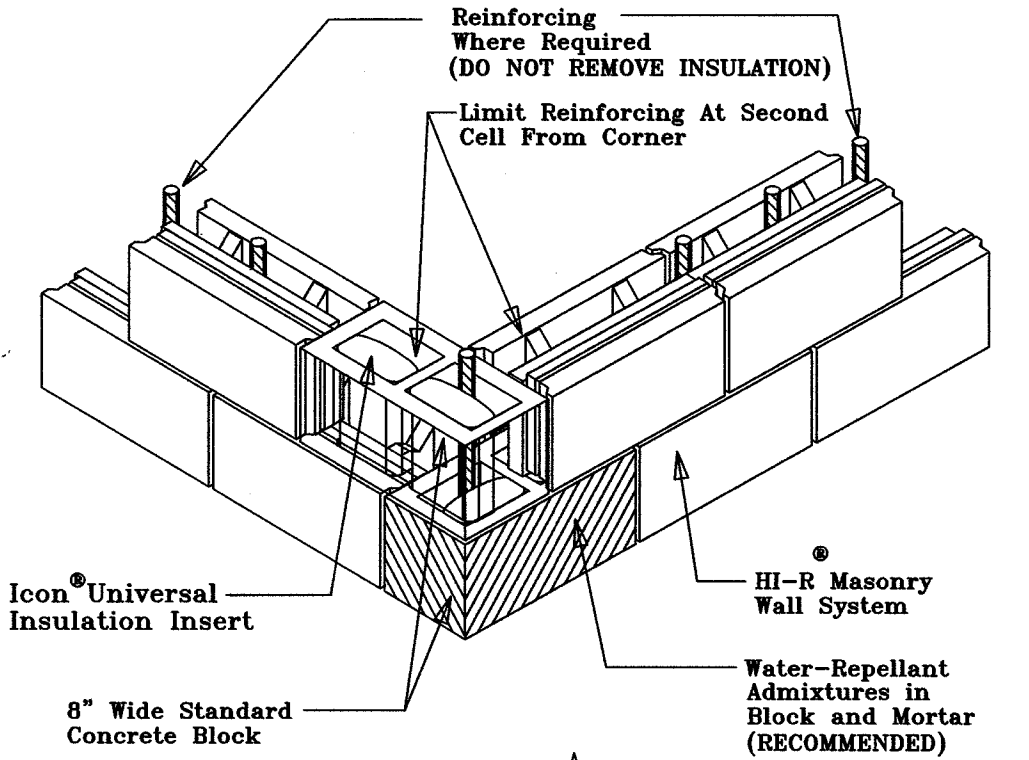

Plan View

DETAILS

6/1/01 | HI-R 3

NOTICE: This Detail is for the Discretionary Use of the Architect. CBIS Assumes No Responsibility For Any Misuse Or Misrepresentation of the Product Or This Detail.

Concrete Block Insulating Systems
 P.O. Box 1000
 Freight House Road
 West Brookfield, MA 01585
 www.cbisinc.com



HI-R[®] WALL SYSTEM

10" & 12" Reinforced Corner Detail

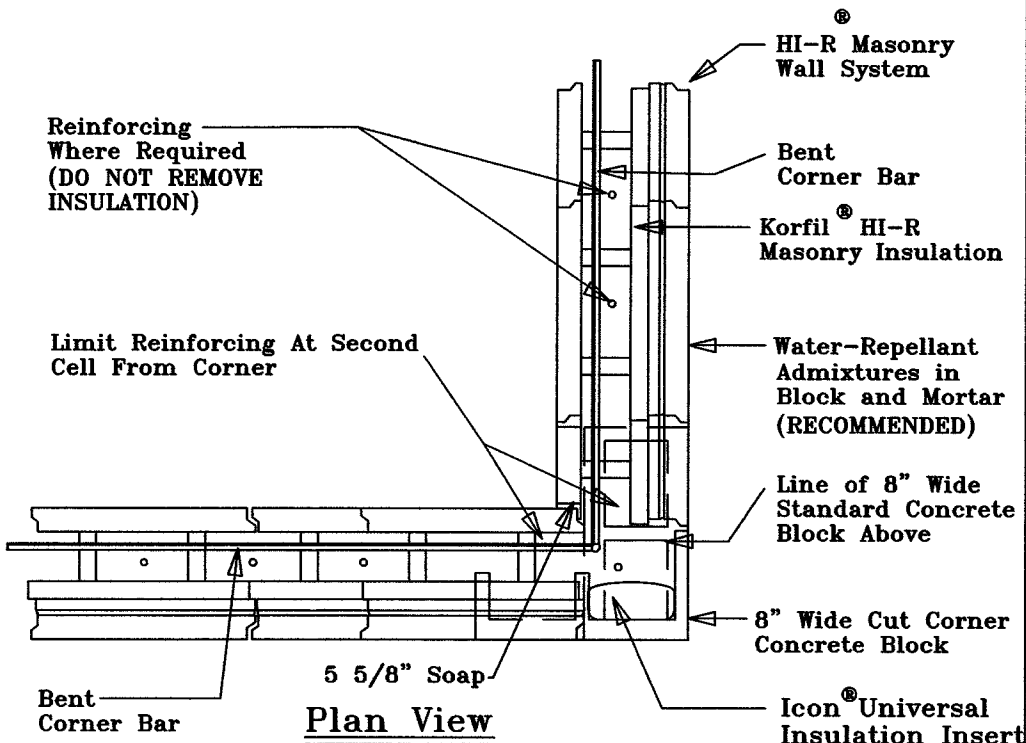
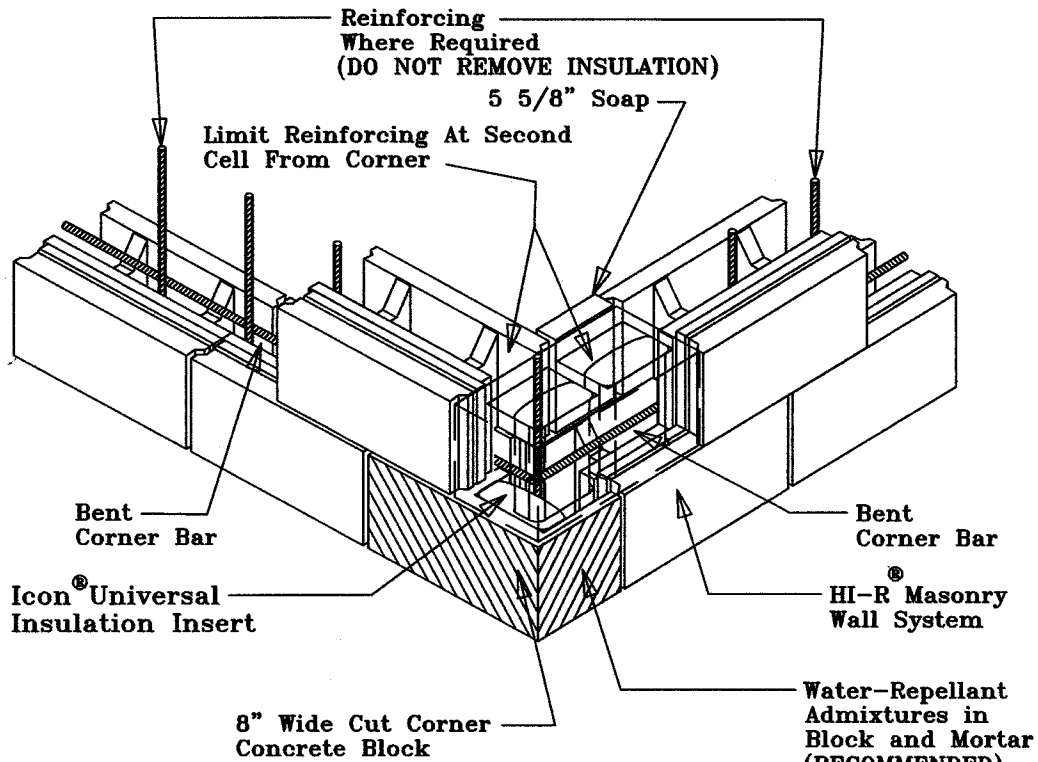

DETAILS

6/1/01 | HI-R 4



NOTICE: This Detail is for the Discretionary Use of the Architect. CBIS Assumes No Responsibility For Any Misuse Or Misrepresentation of the Product Or This Detail.

Concrete Block Insulating Systems
 P.O. Box 1000
 Freight House Road
 West Brookfield, MA 01585
 www.cbisinc.com

HI-R[®] WALL SYSTEM

8", 10" & 12" Standard Door Jam Detail

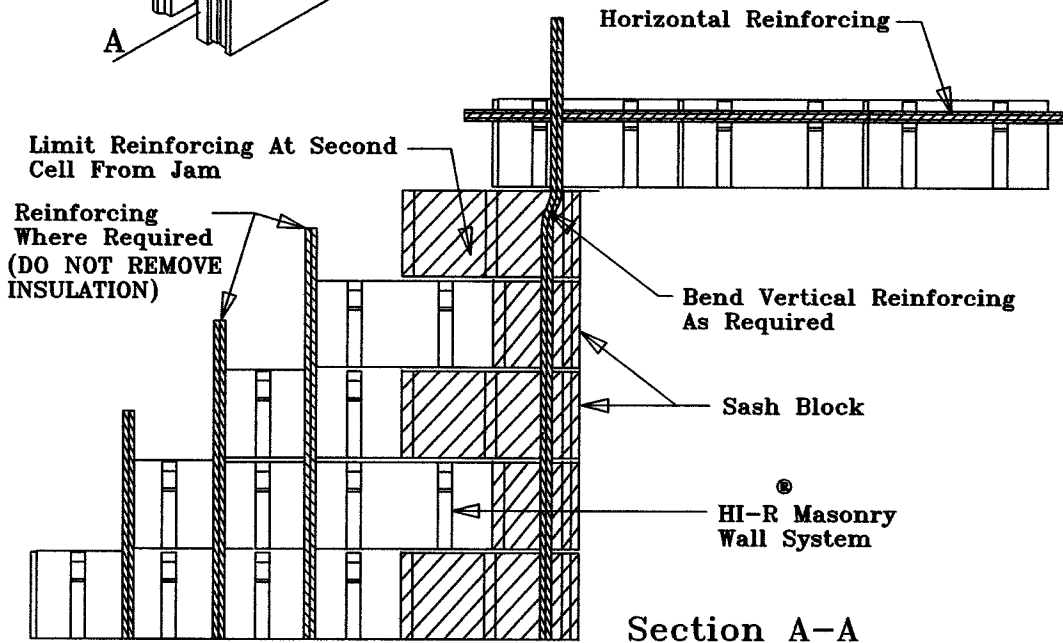
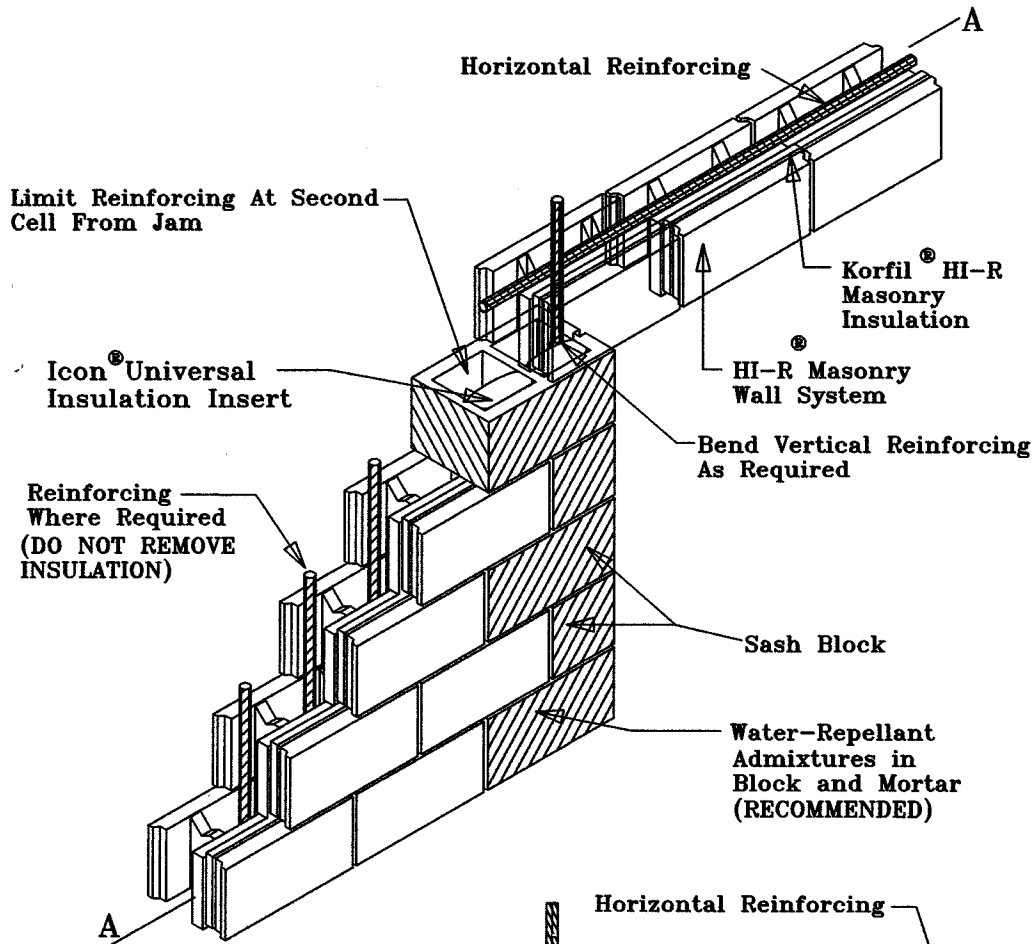

Section A-A

DETAILS

6/1/01 | HI-R 5

NOTICE: This Detail is for the Discretionary Use of the Architect. CBIS Assumes No Responsibility For Any Misuse Or Misrepresentation of the Product Or This Detail.

Concrete Block Insulating Systems
 P.O. Box 1000
 Freight House Road
 West Brookfield, MA 01585
 www.cbisinc.com



HI-R[®] WALL SYSTEM

8", 10", & 12" Standard Window Jam Detail

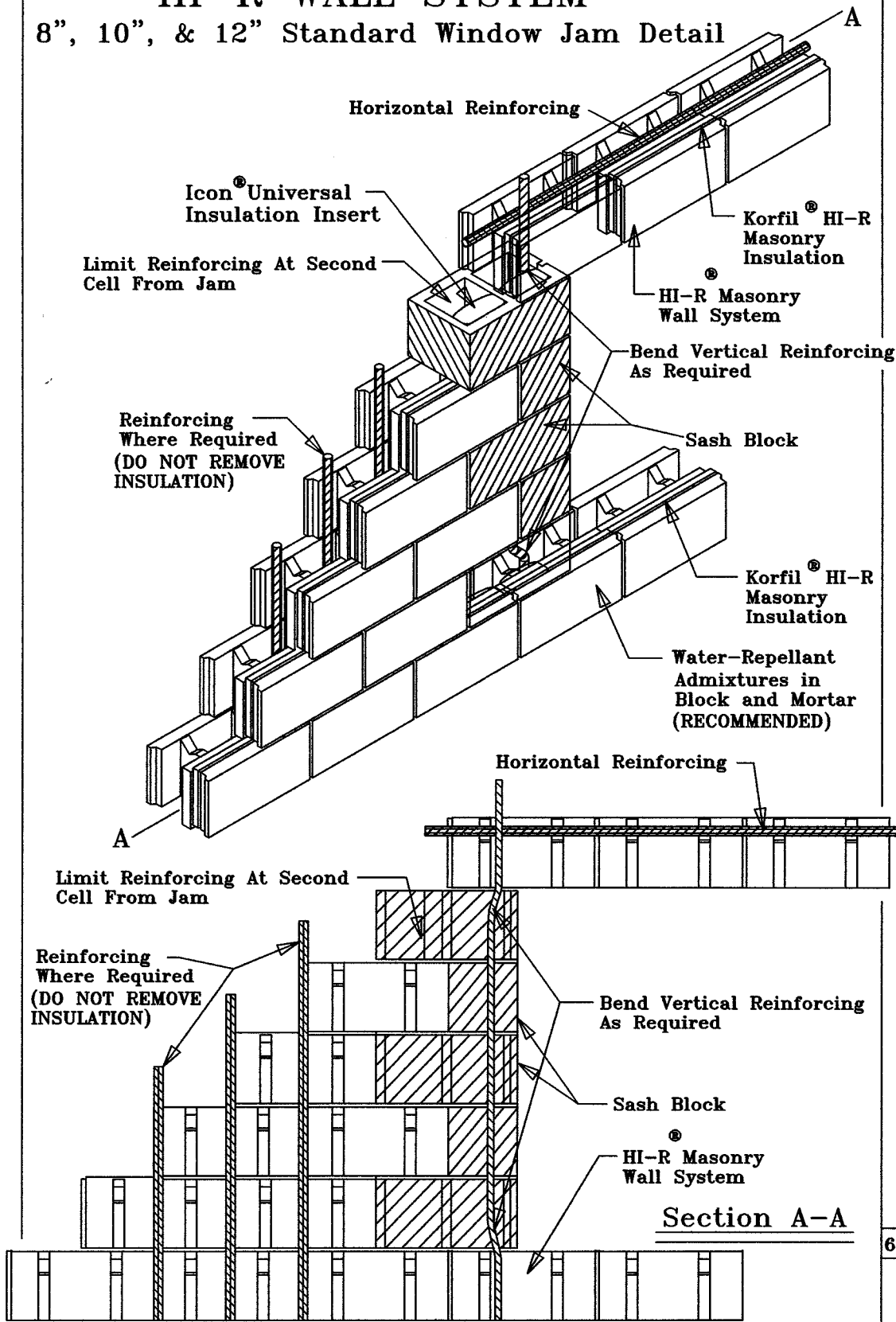

DETAILS

6/1/01 | HI-R 6

NOTICE: This Detail is for the Discretionary Use of the Architect. CBIS Assumes No Responsibility For Any Misuse Or Misrepresentation of the Product Or This Detail.

Concrete Block Insulating Systems
 P.O. Box 1000
 Freight House Road
 West Brookfield, MA 01585
 www.cbisinc.com



HI-R[®] WALL SYSTEM 8" THRU WALL BASE DETAIL

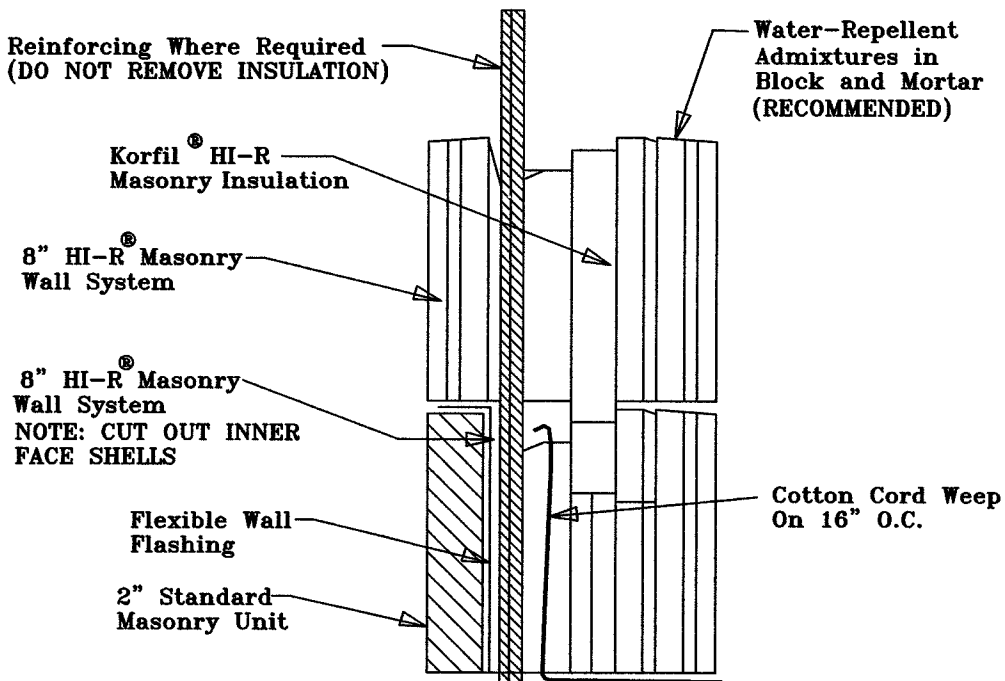
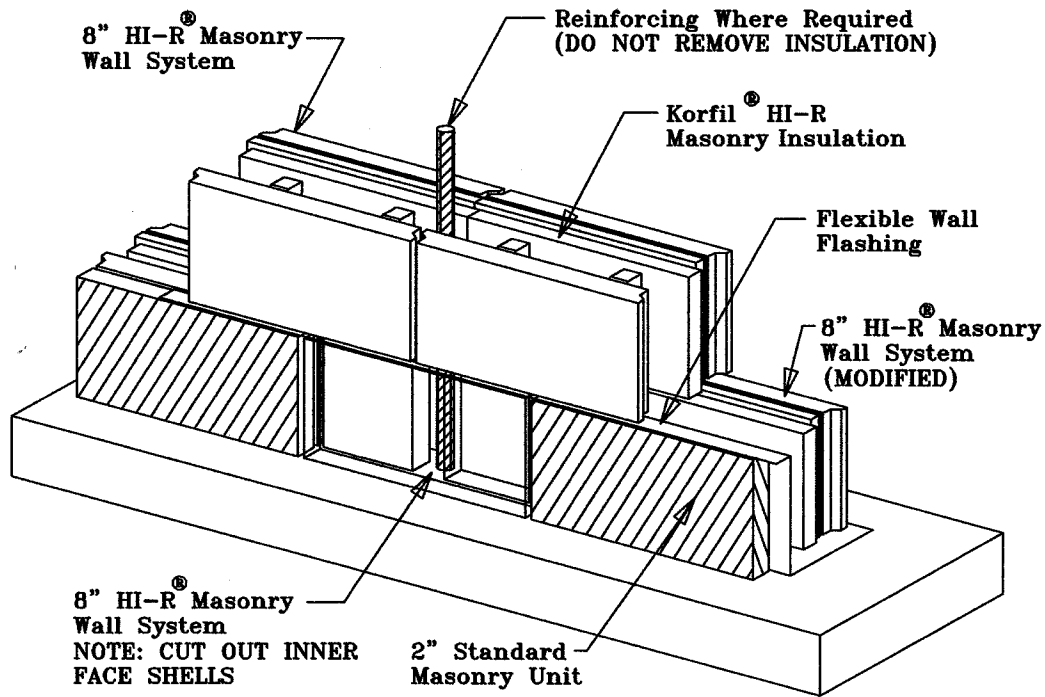

DETAILS

10/1/98 HI-R 7

NOTICE: This Detail is for the Discretionary Use of the Architect. CBIS Assumes No Responsibility For Any Misuse Or Misrepresentation of the Product Or This Detail.

Concrete Block Insulating Systems
P.O. Box 1000
Freight House Road
West Brookfield, MA 01585



HI-R[®] WALL SYSTEM 10" THRU WALL BASE DETAIL

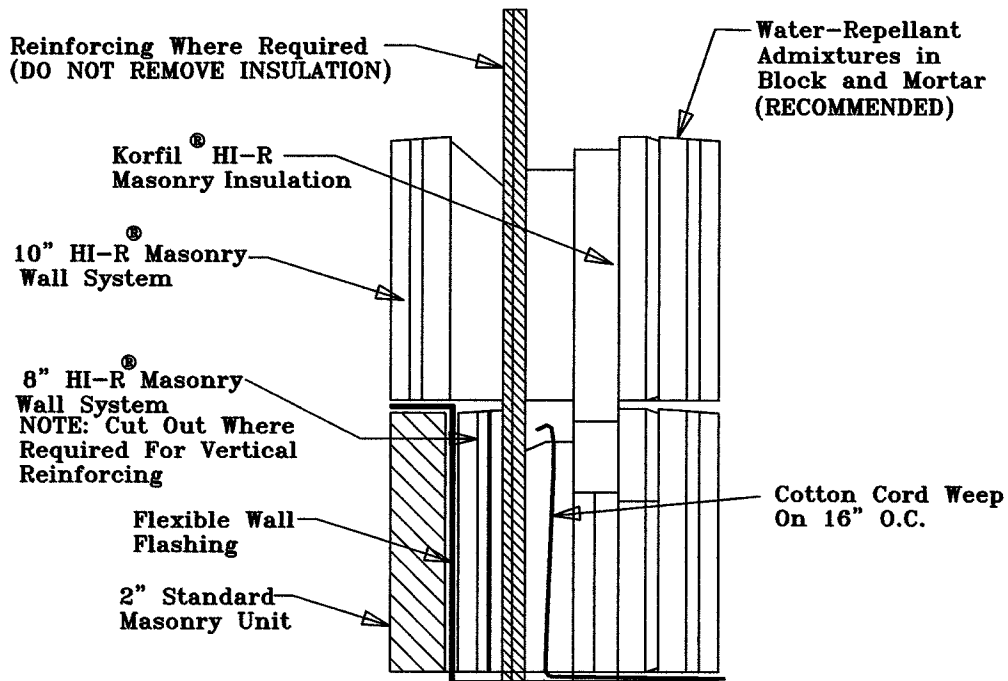
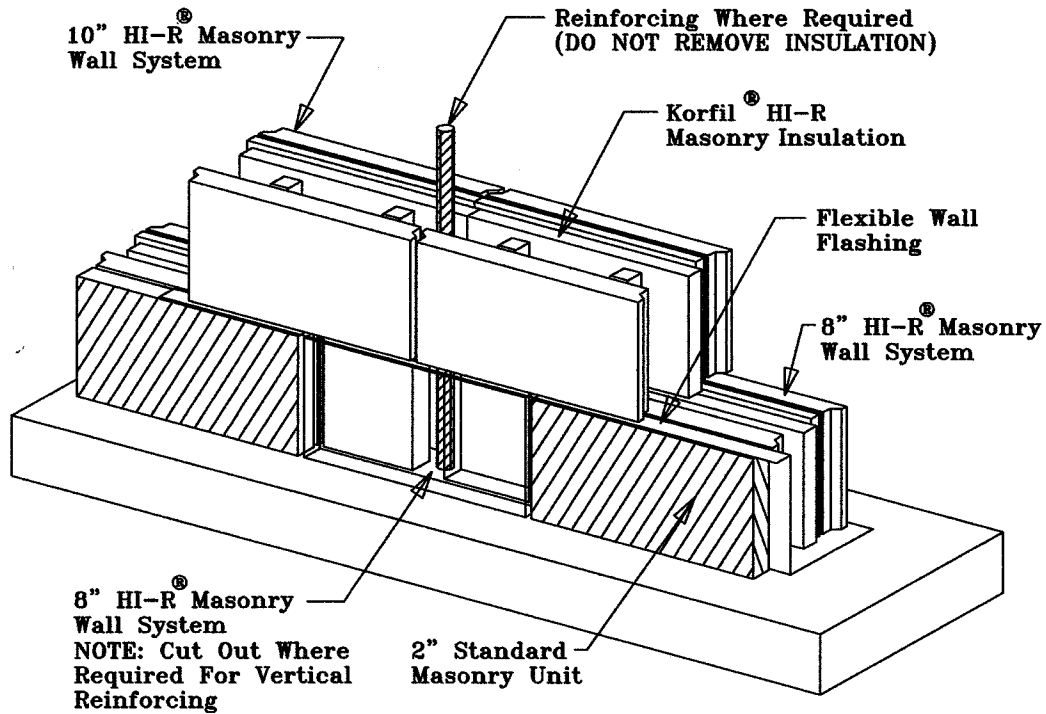

DETAILS

6/1/01 HI-R 8

NOTICE: This Detail is for the Discretionary Use of the Architect. CBIS Assumes No Responsibility For Any Misuse Or Misrepresentation of the Product Or This Detail.

Concrete Block Insulating Systems
P.O. Box 1000
Freight House Road
West Brookfield, MA 01585
www.cbisinc.com



HI-R[®] WALL SYSTEM 12" THRU WALL BASE DETAIL

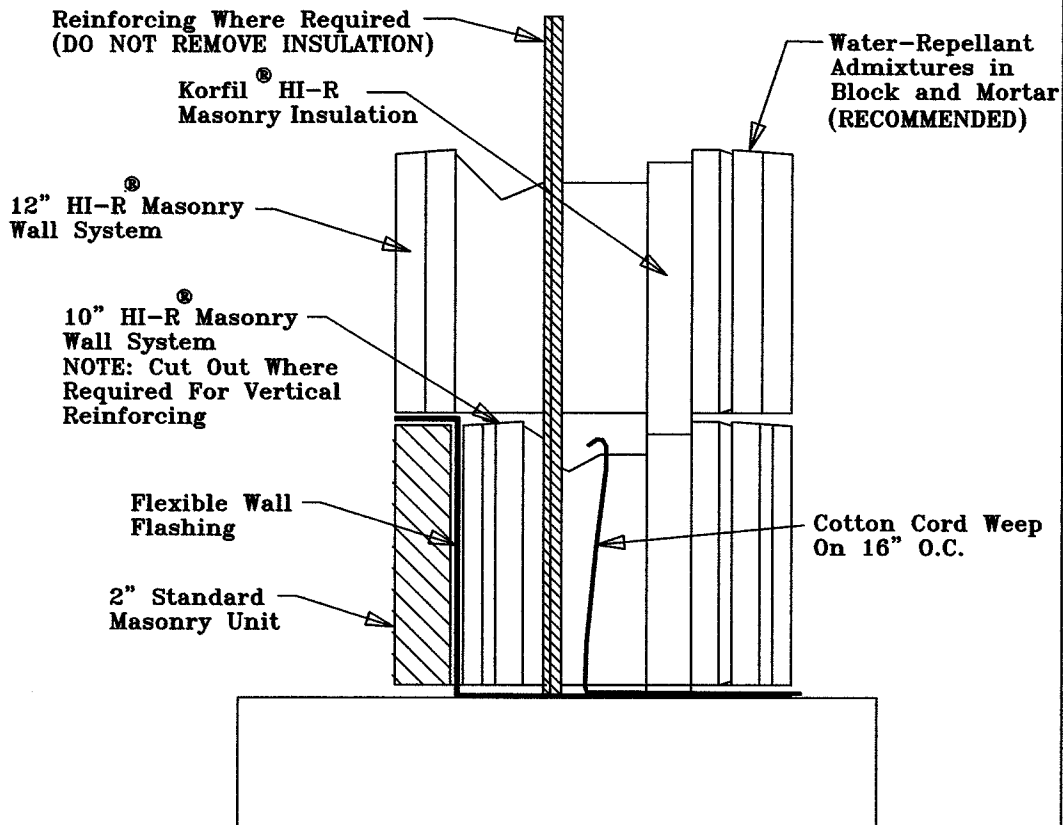
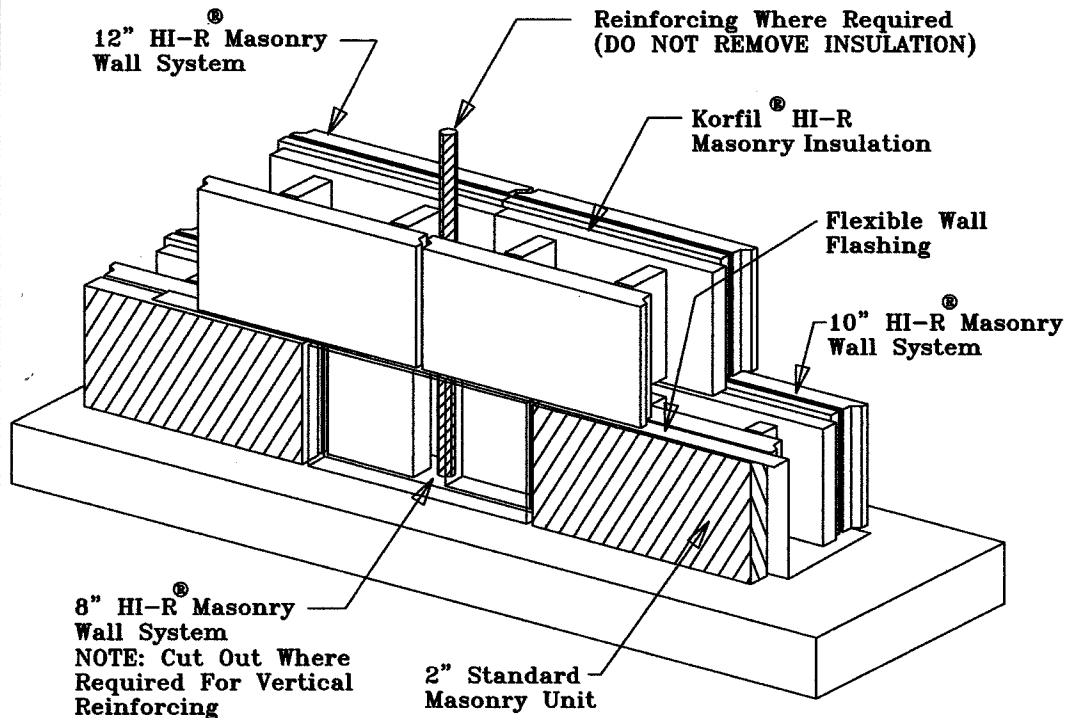

DETAILS

6/1/01 | HI-R 9

NOTICE: This Detail is for the Discretionary Use of the Architect. CBIS Assumes No Responsibility For Any Misuse Or Misrepresentation of the Product Or This Detail.

Concrete Block Insulating Systems
P.O. Box 1000
Freight House Road
West Brookfield, MA 01585
www.cbisinc.com



HI-R[®] WALL SYSTEM

8" Window Head Thru Flashing

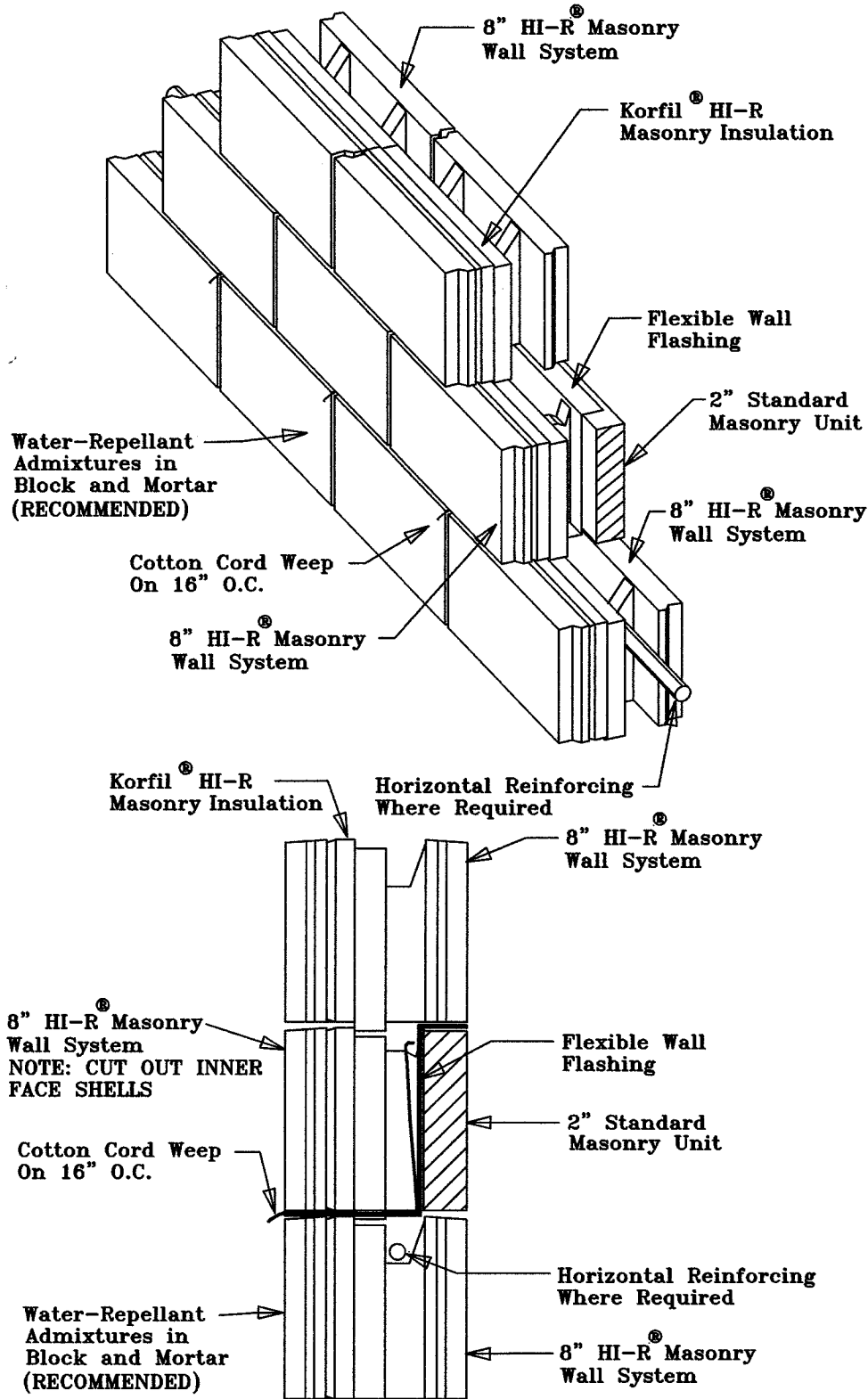

DETAILS

6/1/01 HI-R 10



NOTICE: This Detail is for the Discretionary Use of the Architect. CBIS Assumes No Responsibility For Any Misuse Or Misrepresentation of the Product Or This Detail.

Concrete Block Insulating Systems
 P.O. Box 1000
 Freight House Road
 West Brookfield, MA 01585
 www.cbisinc.com

HI-R[®] WALL SYSTEM

10" Window Head Thru Flashing

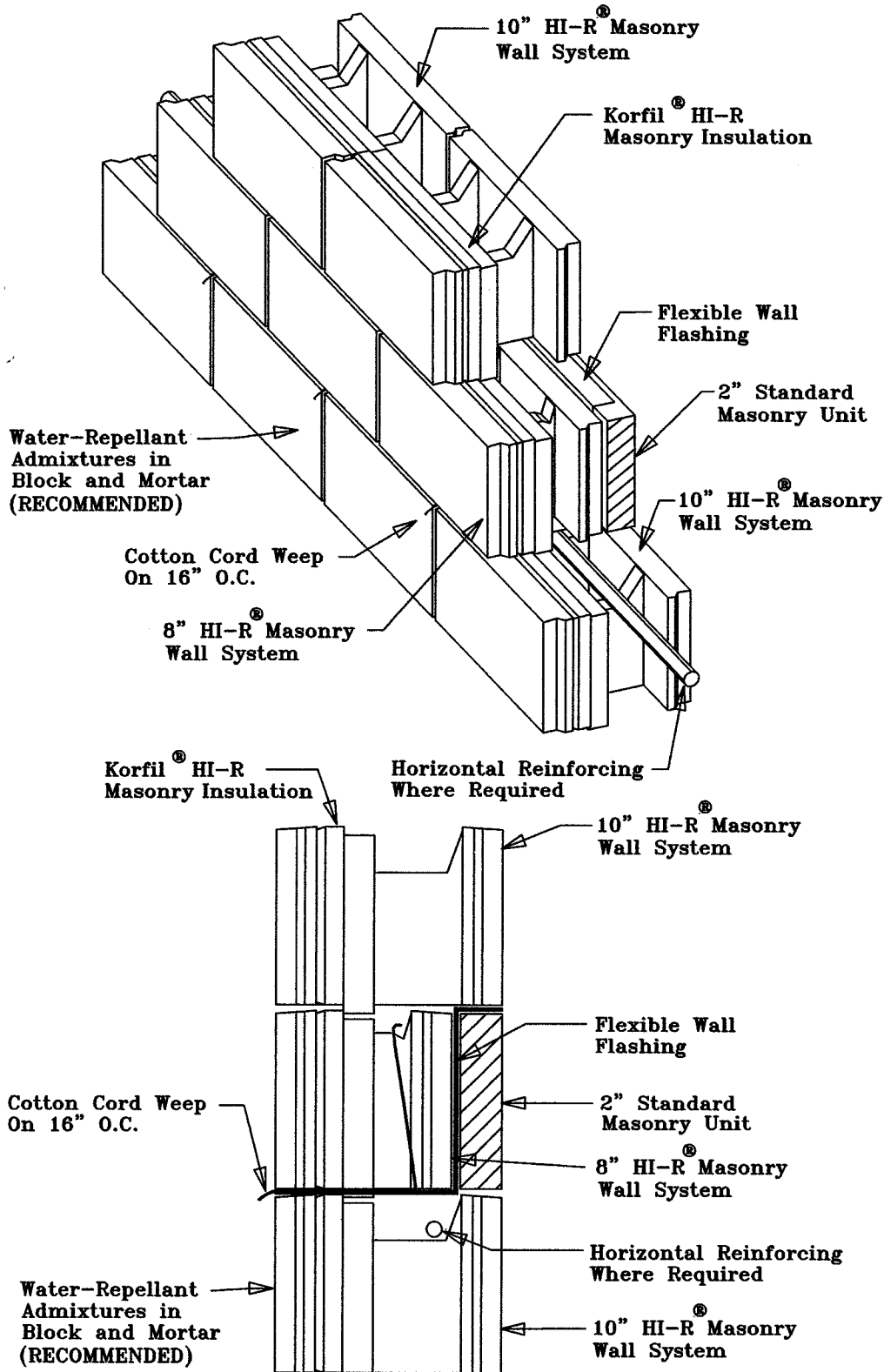

DETAILS

6/1/01 | HI-R 11



NOTICE: This Detail is for the Discretionary Use of the Architect. CBIS Assumes No Responsibility For Any Misuse Or Misrepresentation of the Product Or This Detail.

Concrete Block Insulating Systems
 P.O. Box 1000
 Freight House Road
 West Brookfield, MA 01585
 www.cbisinc.com

HI-R[®] WALL SYSTEM 12" WINDOW HEAD THRU FLASHING

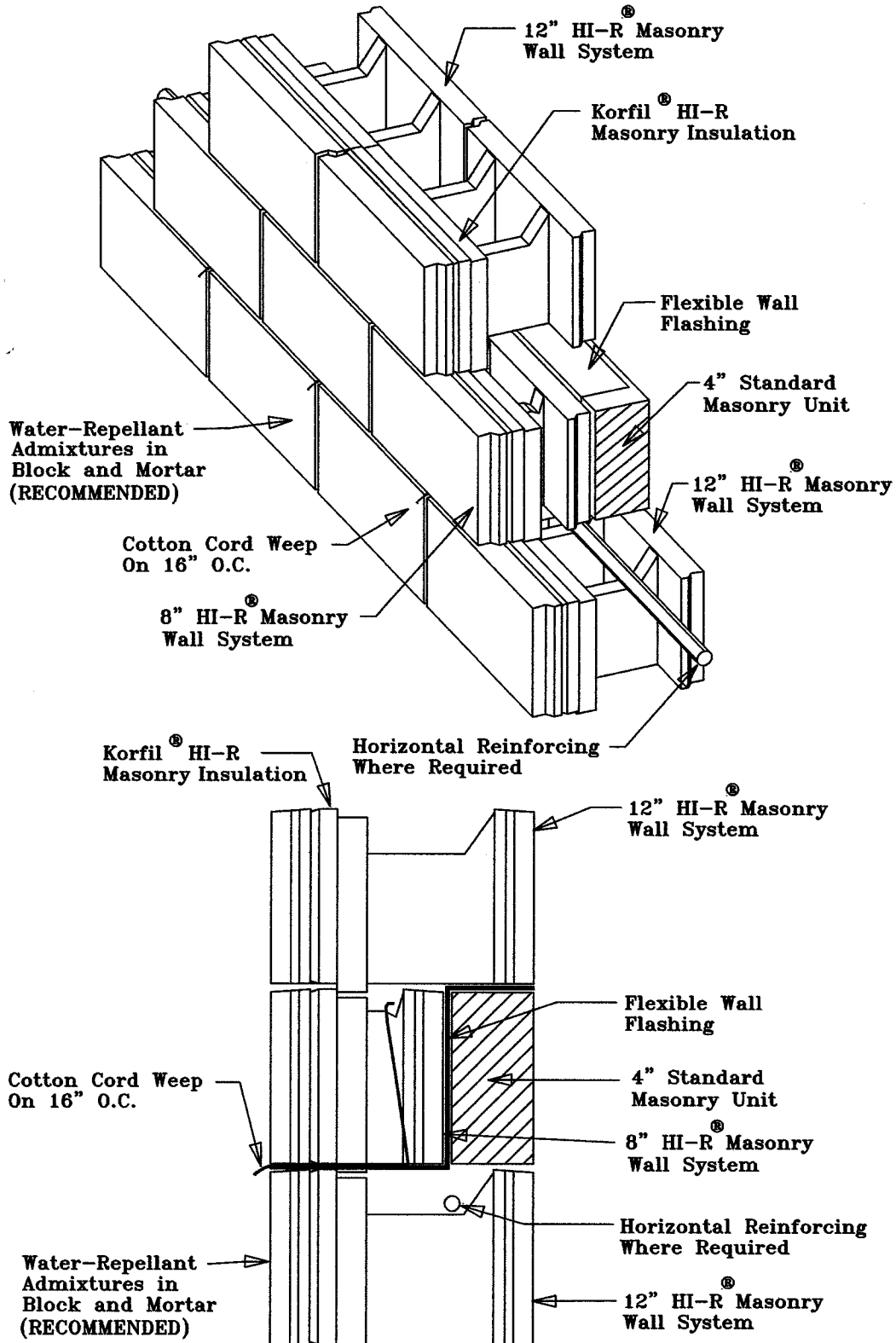

DETAILS

6/1/01 | HI-R 12



NOTICE: This Detail is for the Discretionary Use of the Architect. CBIS Assumes No Responsibility For Any Misuse Or Misrepresentation of the Product Or This Detail.

Concrete Block Insulating Systems
P.O. Box 1000
Freight House Road
West Brookfield, MA 01585
www.cbisinc.com

HI-R[®] WALL SYSTEM

8" THRU WALL BASE DETAIL (ALT)

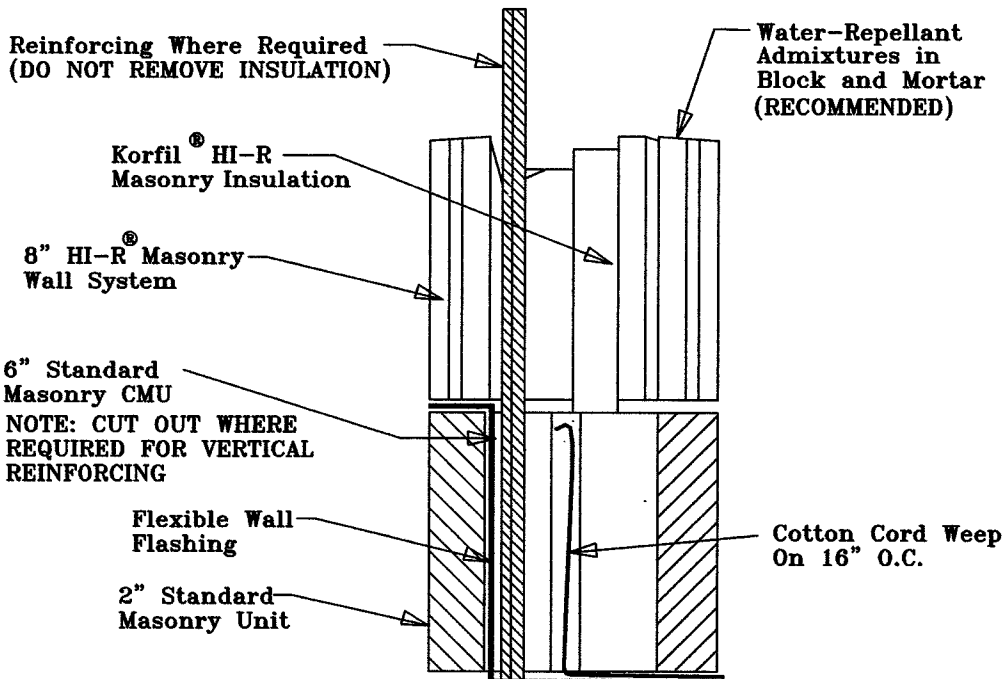
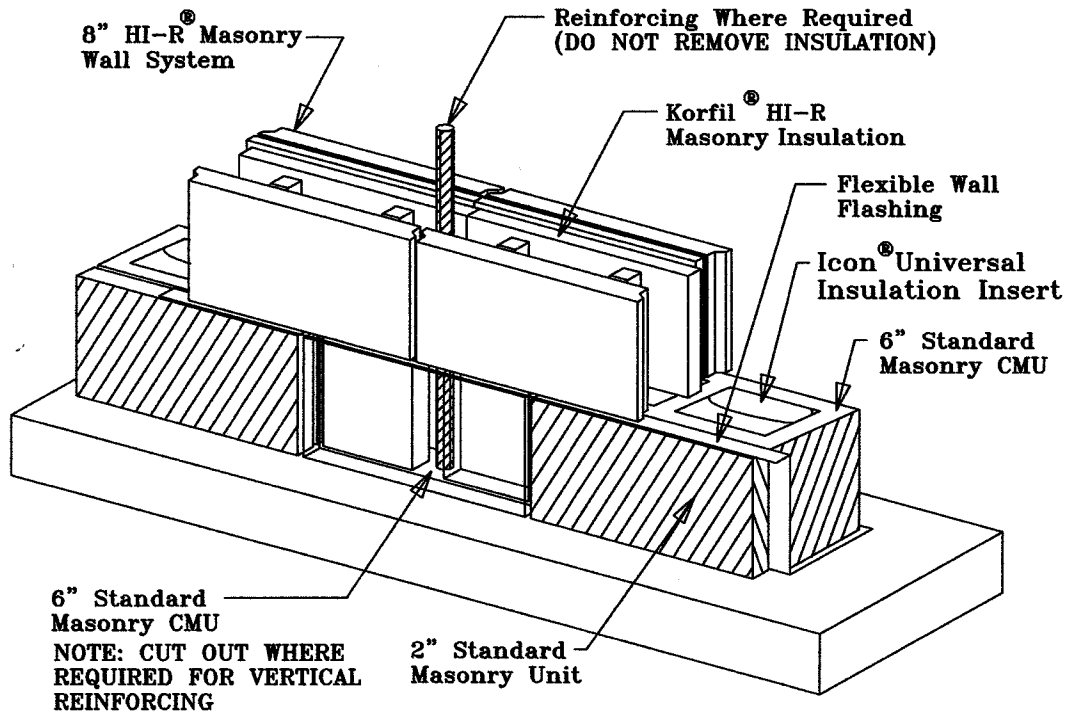

DETAILS

6/1/01 HI-R 14

NOTICE: This Detail is for the Discretionary Use of the Architect. CBIS Assumes No Responsibility For Any Misuse Or Misrepresentation of the Product Or This Detail.

Concrete Block Insulating Systems
 P.O. Box 1000
 Freight House Road
 West Brookfield, MA 01585
 www.cbisinc.com



HI-R[®] WALL SYSTEM

8" Window Head Thru Flashing (ALT)

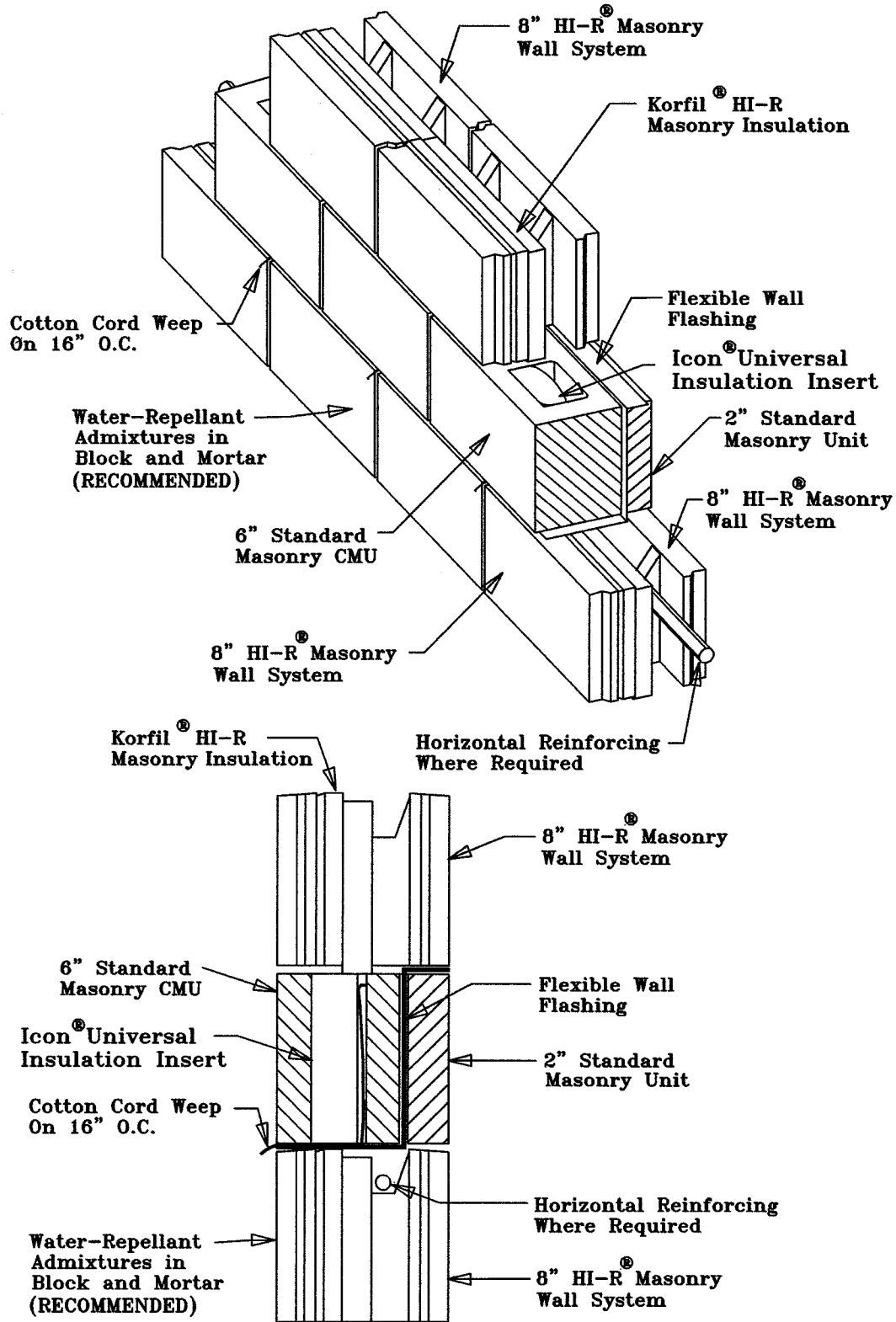

DETAILS

6/1/01 | HI-R 15



NOTICE: This Detail is for the Discretionary Use of the Architect. CBIS Assumes No Responsibility For Any Misuse Or Misrepresentation of the Product Or This Detail.

Concrete Block Insulating Systems
 P.O. Box 1000
 Freight House Road
 West Brookfield, MA 01585
www.cbisinc.com

HI-R[®] WALL SYSTEM

8", 10" & 12" Optional Door Jam Detail

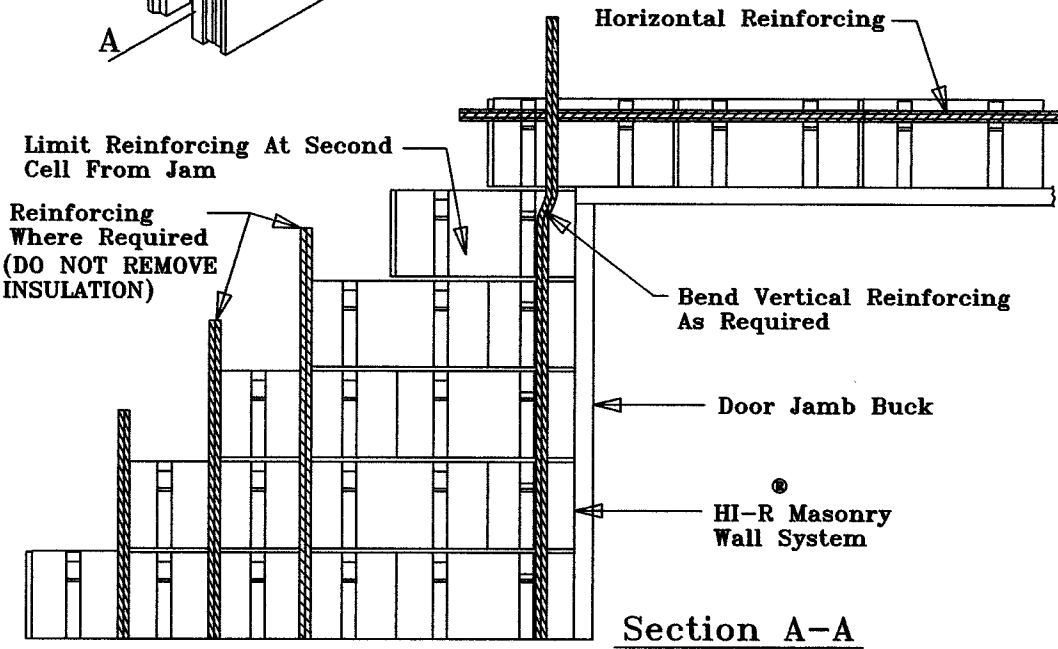
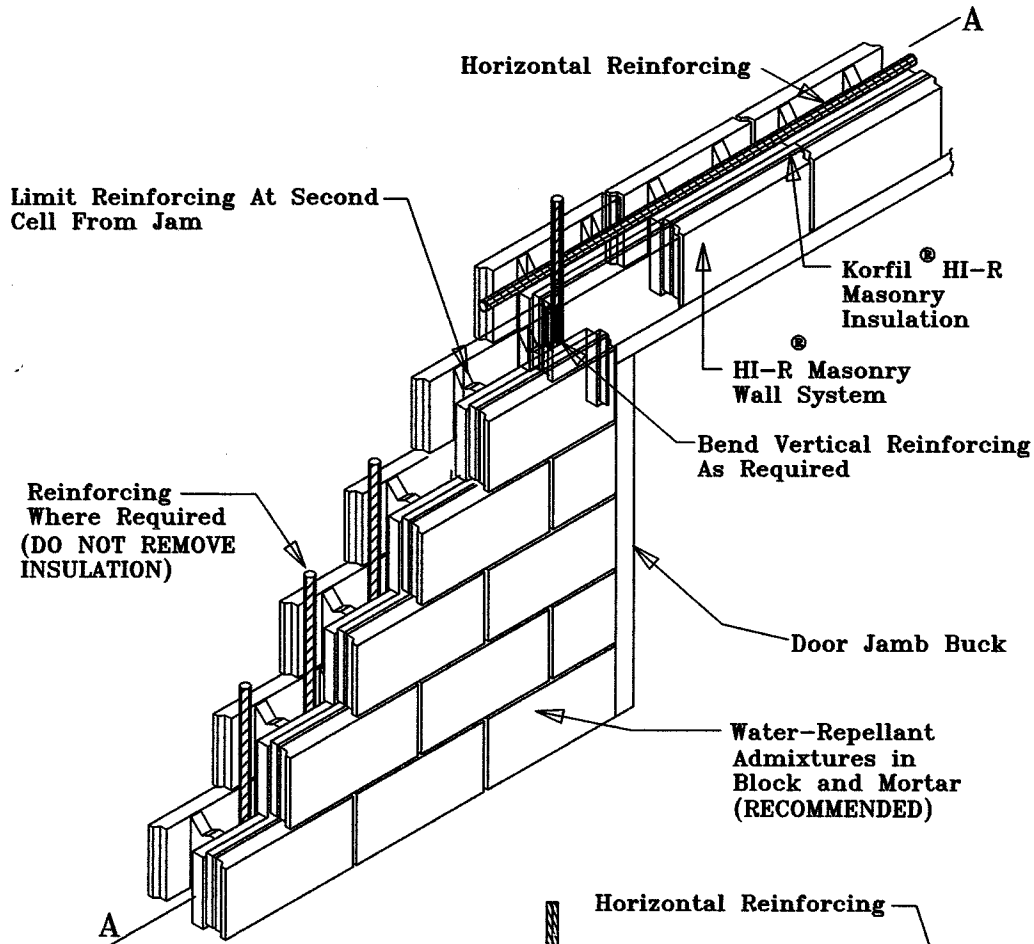

DETAILS

9/23/04 HI-R 16

NOTICE: This Detail is for the Discretionary Use of the Architect. CBIS Assumes No Responsibility For Any Misuse Or Misrepresentation of the Product Or This Detail.

Concrete Block Insulating Systems
 P.O. Box 1000
 Freight House Road
 West Brookfield, MA 01585
 www.cbisinc.com



HI-R[®] WALL SYSTEM

8", 10", & 12" Optional Window Jam Detail

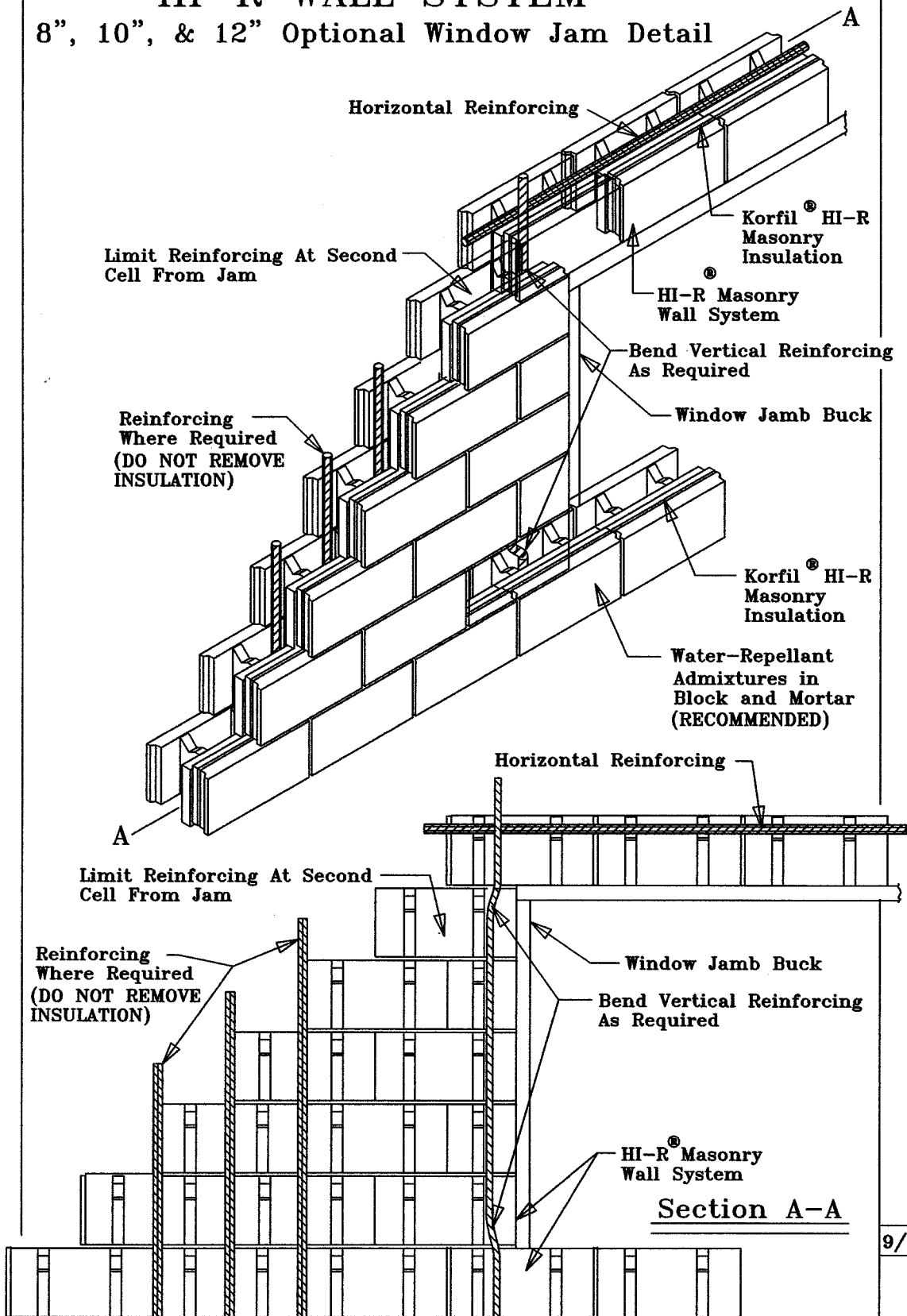

DETAILS

9/23/04 HI-R 17

NOTICE: This Detail is for the Discretionary Use of the Architect. CBIS Assumes No Responsibility For Any Misuse Or Misrepresentation of the Product Or This Detail.

Concrete Block Insulating Systems
 P.O. Box 1000
 Freight House Road
 West Brookfield, MA 01585
 www.cbisinc.com



HI-R[®] WALL SYSTEM

12" Alternate Corner Detail

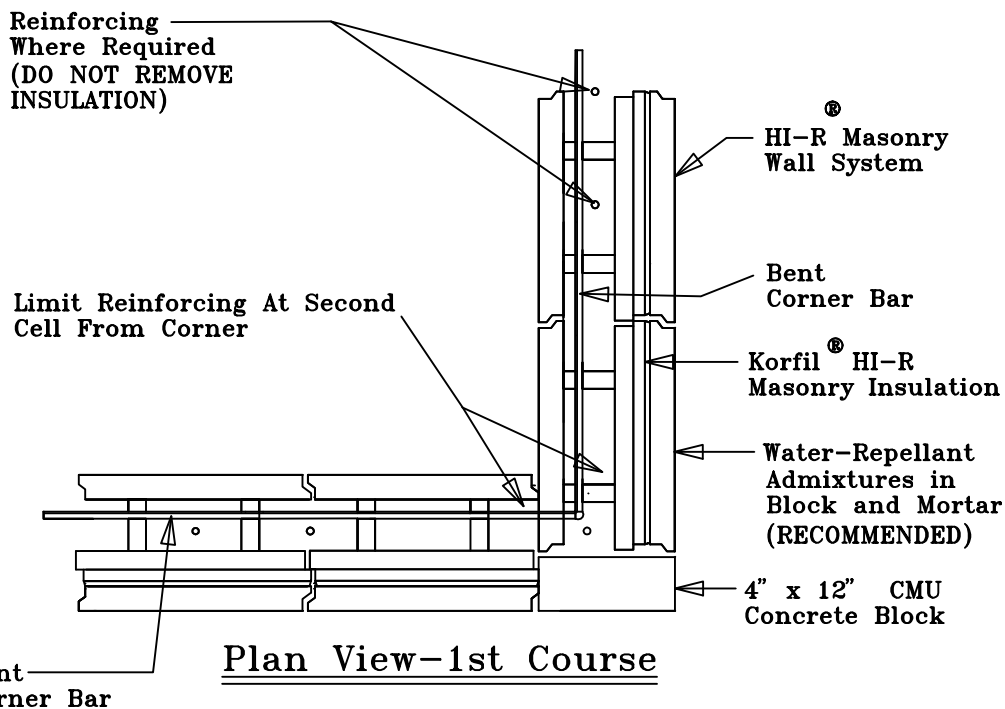
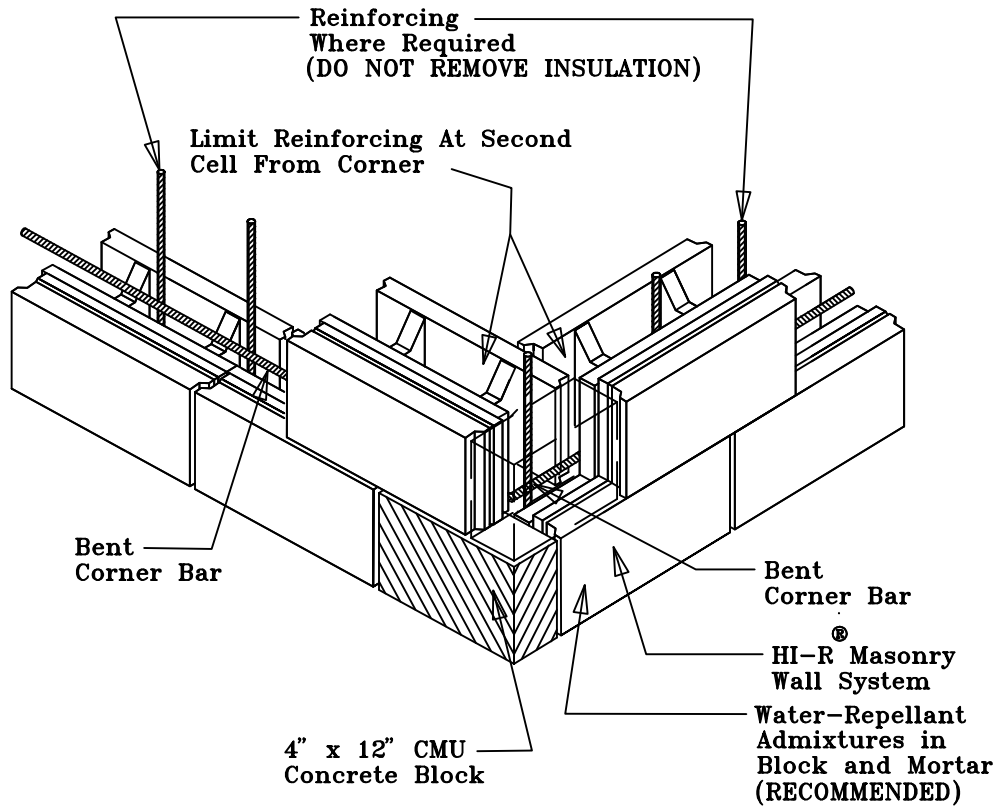

DETAILS

1/12/06 HI-R 18

NOTICE: This Detail is for the Discretionary Use of the Architect. CBIS Assumes No Responsibility For Any Misuse Or Misrepresentation of the Product Or This Detail.

Concrete Block Insulating Systems
 P.O. Box 1000
 Freight House Road
 West Brookfield, MA 01585
 www.cbisinc.com

